

## Specificatii

Tensiune nominala	12V	
Capacitate nominala (15 min)	21W / celula	
Dimensiuni	Lungime	90 ± 1,5mm
	Latime	70 ± 1mm
	Inaltime carcasa	101 ± 1mm
	Inaltime totala (cu borne)	107 ± 1mm
Greutate	Approx 1,62kg	
Borne	T2/T1	
Material carcasa	ABS	
Capacitate	5,0Ah / 0,25A	20Hr, 1,80V/celula, 25oC
	4,45Ah / 0,89A	5Hr, 1,75V/celula, 25oC
	3,84Ah / 1,28A	3Hr, 1,75V/celula, 25oC
	3,58Ah / 3,58A	1Hr, 1,60V/celula, 25oC
	21W / celula	15 min, 1,67V/celula, 25°C
Curent maxim de descarcare	75A (5s)	
Rezistenta interna	Approx 32mΩ	
Interval temp. de utilizare	Descarcare: -15 ÷ 50°C	
	Incarcare: -10 ÷ 50°C	
	Depozitare: -20 ÷ 50°C	
Temp. nominala de utilizare	25 ± 3°C	
Utilizare ciclica	Curent initial de incarcare: <1,5A. Tensiunea de incarcare: 14,5V ÷ 15,0V la 25°C. Coef. de corectie cu temperatura: -30mV / °C	
Utilizare tampon (stand-by)	Curent initial de incarcare: <1,5A. Tensiunea de incarcare: 13,5V ÷ 13,8V at 25°C. Coef. de corectie cu temperatura: -18mV / °C	
Influenta temperaturii asupra capacitatii	40°C	102%
	25°C	100%
	0°C	85%
Autodescercare la 25°C	3 luni	Capacitate remanenta: 91%
	6 luni	Capacitate remanenta: 82%
	12 luni	Capacitate remanenta: 65%

## Gama FH / FH12-5



## Utilizari si caracteristici

Tehnologie: VRLA

Uninterruptible Power Supply (UPS)

Electric Power System (EPS)

Sisteme de semnalizare feroviare si aeriene

Iluminat de siguranta

Statii de alimentare electrica

Sisteme de alarma si securitate

Surse de alimentare cu C.C.

EN 60896-21,-22

Durata de viata proiectata: 5 ani

Eurobat: Standard Comercial

Bateriile din gama FOTON FH pot fi stocate pina la 6 luni la 25°C dupa care este recomandata o incarcare de improspatare

## Descarcare cu curent constant (Amperi) la 25°C

Ufinal/timp	5min	10min	15min	20min	30min	45min	60min	2h	3h	4h	5h
1.60V/cell	22.8	14.0	11.0	8.71	5.90	4.37	3.58	1.84	1.31	1.05	0.90
1.67V/cell	21.7	13.4	10.6	8.36	5.71	4.23	3.49	1.82	1.29	1.04	0.89
1.70V/cell	21.2	13.0	10.3	8.19	5.61	4.15	3.43	1.81	1.29	1.04	0.89
1.75V/cell	20.3	12.5	10.0	7.91	5.47	4.05	3.36	1.78	1.28	1.03	0.89
1.80V/cell	19.1	11.8	9.5	7.49	5.27	3.90	3.26	1.74	1.24	1.00	0.86

## Descarcare cu putere constanta (Watts/celula) la 25oC

Ufinal/timp	5min	10min	15min	20min	30min	45min	60min	2h	3h	4h	5h
1.60V/cell	43.7	27.2	21.8	17.2	11.7	8.65	7.08	3.66	2.62	2.11	1.81
1.67V/cell	41.7	26.0	21.0	16.6	11.3	8.38	6.90	3.62	2.60	2.09	1.80
1.70V/cell	40.6	25.3	20.5	16.2	11.1	8.22	6.80	3.60	2.59	2.08	1.79
1.75V/cell	38.9	24.2	19.8	15.7	10.8	8.02	6.66	3.55	2.57	2.07	1.78
1.80V/cell	36.7	22.8	18.7	14.8	10.4	7.73	6.46	3.46	2.50	2.01	1.73

### Dimensiuni exetrioare (mm)

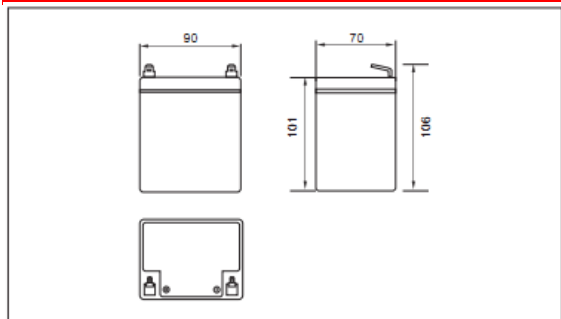

### Tip borne (mm)

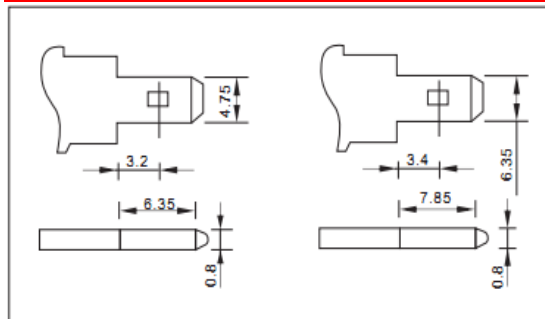

### Caracteristici de descarcare (25°C)

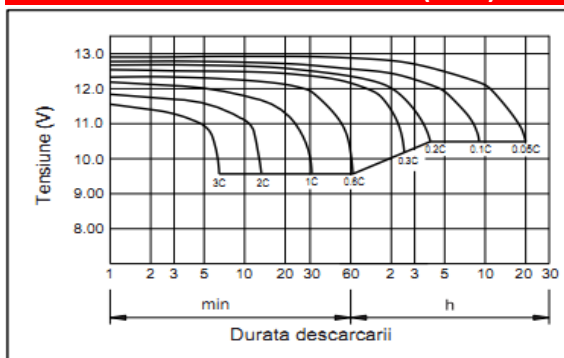

### Caracteristici de incarcare (25°C)

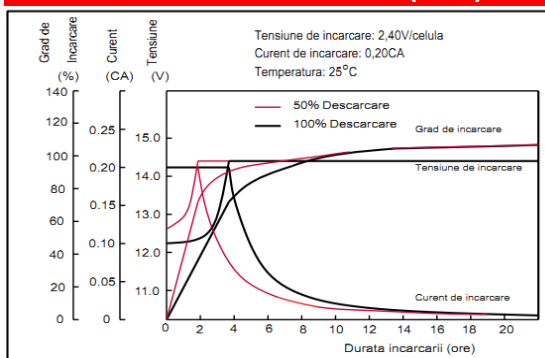

### Efectul temperaturii asupra capacitatii

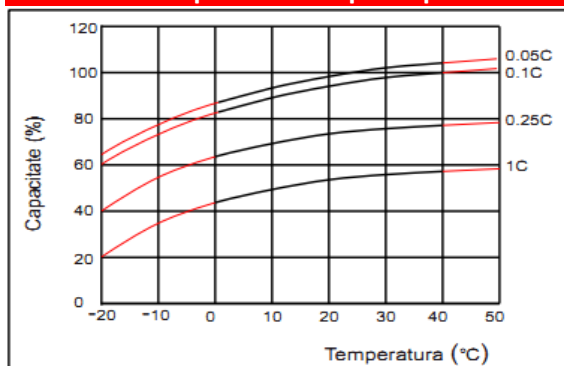

### Durata de viata vs temperatura

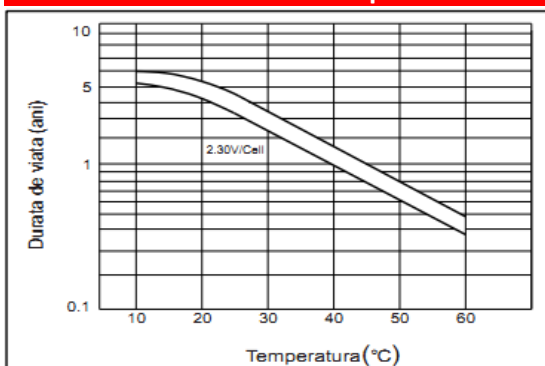

### Nr de cicluri vs adincime de descarcare (25°C)

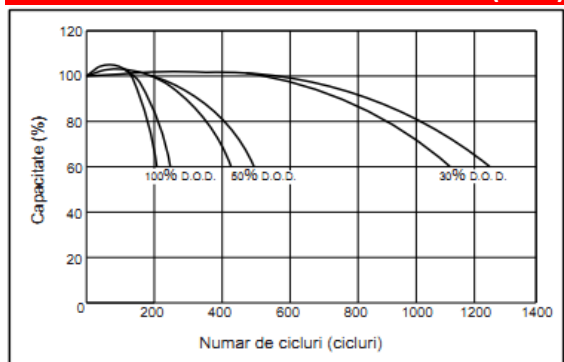

### Capacitate vs tensiune la borne (25°C)

