

Specificatii

Tensiune nominala	12V		
Capacitate nominala (20h)	1,2Ah		
Dimensiuni	Lungime	98 ± 1,5mm	
	Latime	45 ± 1mm	
	Inaltime carcasa	52 ± 1mm	
	Inaltime totala (cu borne)	59 ± 1mm	
Greutate	Approx 0,54kg		
Tip Borna	T1		
Material carcasa	ABS		
Capacitate	1,2Ah / 0,06A	20Hr, 1,75V/cell, 25°C	
	1,1AhAh / 0,11A	10Hr, 1,75V/cell, 25°C	
	1,05Ah / 0,21A	5Hr, 1,75V/cell, 25°C	
	0,87Ah / 0,29A	3Hr, 1,75V/cell, 25°C	
	0,79Ah / 0,79A	1Hr, 1,60V/cell, 25°C	
Curent maxim de descarcare	18A (5s)		
Rezistenta interna	Approx 90mΩ		
Interval temp. de utilizare	Descarcare: -15 ÷ 50°C		
	Incarcare: -10 ÷ 50°C		
	Depozitare: -20 ÷ 50°C		
Temp. nominala de utilizare	25 ± 3°C		
Utilizare ciclica	Curent initial de incarcare: <0,36A. Tensiunea de incarcare: 14,5V ÷ 15,0V la 25°C. Coef. de corectie cu temperatura: -30mV /		
Utilizare tampon (stand-by)	Curent initial de incarcare: <0,36A. Tensiunea de incarcare: 13,5V ÷ 13,8V at 25°C. Coef. de corectie cu temperatura: -18mV /		
Influenta temperaturii asupra capacitatii	40°C	102%	25°C 100%
	0°C	85%	-15°C 65%
Autodescarcare la 25°C	3 luni	Capacitate remanenta: 91%	
	6 luni	Capacitate remanenta: 82%	
	12 luni	Capacitate remanenta: 65%	

Gama FS / FS12-1,2



Poza cu titlu de prezentare

Utilizari si caracteristici

Tehnologie: VRLA

Surse neinteruptibile de tensiune (UPS)

Sisteme electrice de alimentare (EPS)

Sisteme de semnalizare aeriene si feroviare

Iluminat de siguranta

Centrale electrice

Sisteme de alarma si securitate

Surse de alimentare cu C.C.

EN 60896-21,-22

Durata de viata proiectata: 5 ani

Eurobat: Standard Comercial

Bateriile din gama FOTON FS pot fi stocate

pina la 6 luni la 25°C dupa care este

recomandata o incarcare de improspatare

Descarcare cu curent constant (Amperi) la 25°C

Ufinal/timp	5min	10min	15min	30min	60min	2h	3h	4h	5h	10h	20h
9.60V	4.58	2.90	2.27	1.28	0.79	0.43	0.30	0.25	0.21	0.11	0.06
9.90V	4.45	2.82	2.21	1.25	0.77	0.43	0.30	0.24	0.21	0.11	0.06
10.2V	4.26	2.70	2.13	1.21	0.75	0.42	0.29	0.24	0.21	0.11	0.06
10.5V	4.08	2.58	2.06	1.18	0.74	0.42	0.29	0.24	0.21	0.11	0.06
10.8V	3.85	2.44	1.95	1.14	0.72	0.41	0.28	0.23	0.20	0.11	0.06

Descarcare cu putere constanta (Watts/bloc) la 25°C

Ufinal/timp	5min	10min	15min	30min	60min	2h	3h	4h	5h	10h	20h
9.60V	51.2	32.8	25.9	14.6	9.10	5.03	3.53	2.93	2.50	1.36	0.73
9.90V	49.6	31.8	25.2	14.4	8.97	5.00	3.51	2.91	2.48	1.36	0.73
10.2V	47.6	30.5	24.3	13.9	8.74	4.96	3.49	2.89	2.47	1.35	0.72
10.5V	45.5	29.2	23.5	13.6	8.56	4.88	3.46	2.87	2.45	1.34	0.72
10.8V	43.0	27.5	22.2	13.1	8.30	4.76	3.36	2.79	2.38	1.32	0.71

Valorile se pot modifica fără înștiințare prealabilă.

Dimensiuni exterioare (mm)

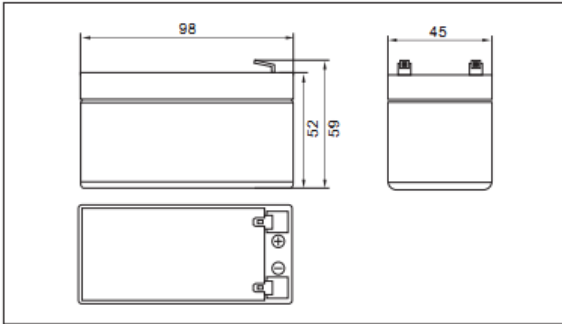

Tip Borna (mm)

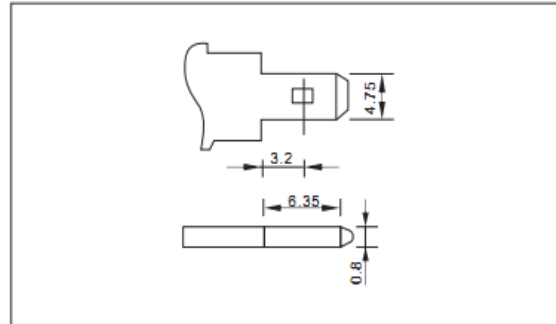

Caracteristici de descarcare (25°C)

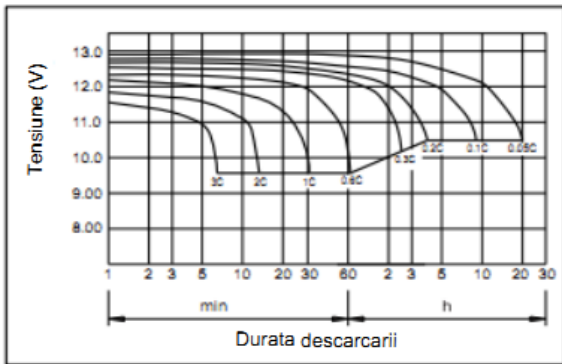

Caracteristici de incarcare (25°C)

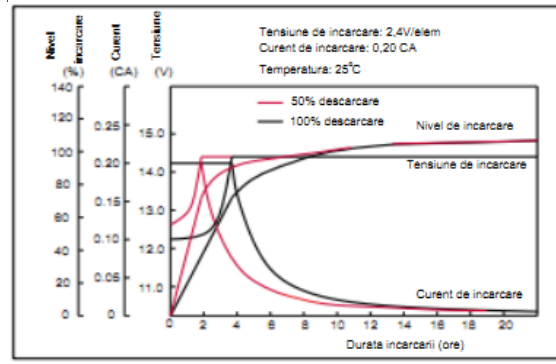

Efectul temperaturii asupra capacitatii

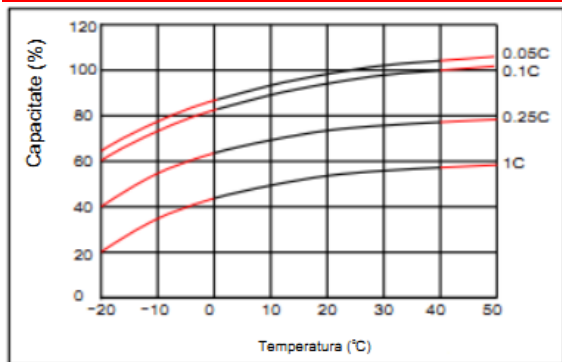

Durata de viata in functie de temperatura

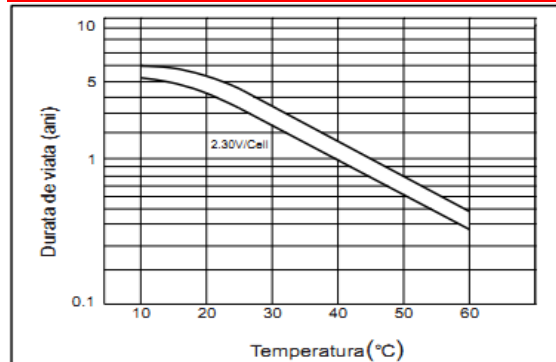

Numar de cicluri vs D.O.D (25°C)

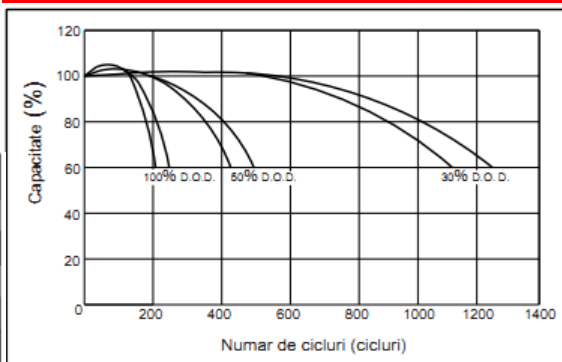

Relatia tensiune la borne / capacitate (25°C)

